

MAINTENANCE REMINDER SHEET

X320 with 38" Edge Deck

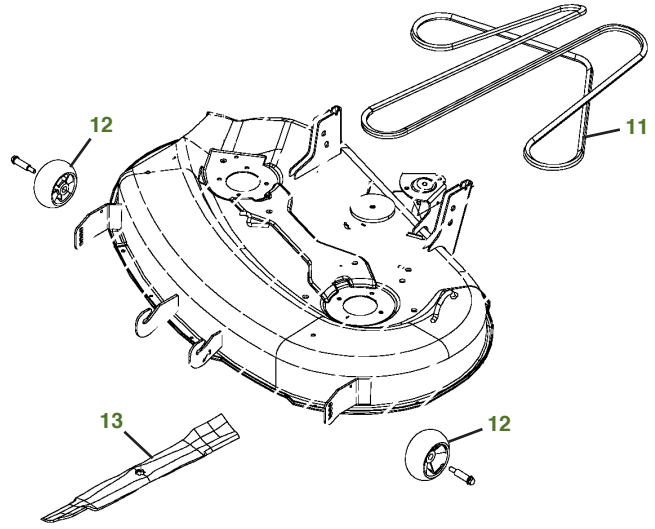
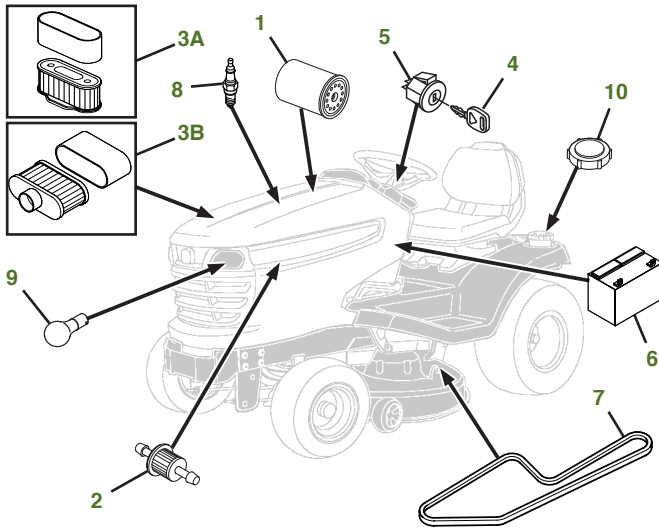

Tractor S/N

Deck S/N

Key	Part No.	Description	Key	Part No.	Description
1	AM107423	ENGINE OIL FILTER-ENG FH661V	7	M151277	BELT-TRAC DRIVE (S/N -150000)
	AM125424	ENGINE OIL FILTER-ENG FS651V		M144044	BELT-TRAC DRIVE (S/N 150001-)
2	AM116304	FUEL FILTER-IN-LINE	8	M805853	SPARK PLUG
3A	M140295	AIR FILTER-FOAM-ENG FH661V	9	AD2062R	HEADLIGHT BULB
	M150949	AIR FILTER-PAPER-ENG FH661V	10	AM137724	FUEL CAP-ENG FH661V
3B	MIU12554	AIR FILTER-FOAM-ENG FS651V		AM141406	FUEL CAP-ENG FS651V
	MIU12555	AIR FILTER-PAPER-ENG FS651V	11	M154601	BELT-MOWER
4	CY20680	KEY	12	M111489	GAGE WHEEL
5	AM133596	IGNITION SWITCH (S/N -040000)	13	AM141039	KIT-SIDE DISCHARGE 38"
	AM133597	IGNITION SWITCH (S/N 040001-)		AM141041	KIT-BAGGING 38"
6	TY25878	BATTERY (S/N -250000)		AM141040	KIT-MULCHING 38"
	TY25221	BATTERY (S/N 250001-)			

Parts Needed in First 250 Hours of Operation

Qty	Part No	Item	Qty or Capacity	Change Interval In Hours
7	TY22029	1 qt Engine Oil Turf-Gard™ 10W30	2.1 qt	8/100/200
3	AM107423 or AM125424	Engine Oil Filter	1	8/100/200
2	M140295 or MIU12554	Air Filter-Foam	1	100/200
2	M150949 or MIU12555	Air Filter-Paper	1	100/200
2	AM116304	Fuel Filter-In-Line	1	100/200
4	M805853	Spark Plug	2	100/200
2	TY6341	JD Multi Purpose SD Polyurea Grease		As Needed

"As Needed" Parts

Qty	Part No	Item
1	AM130907	Mower Deck Leveling Gauge
1	TY26518	Grease Gun

Home Maintenance Kit

Unit	Kit Number
X320	LG249 (Eng FH661V) LG265 (Eng FS651V)

CLICK PART NUMBER TO BUY