

HARVESTERS

1070E/1170E/1270E/1470E



JOHN DEERE







Logging will never be the same.

John Deere E-Series Harvesters represent a revolution in logging, delivering unprecedented productivity and operator comfort. With spacious, quiet cabs that automatically rotate according to operator preference to track the boom and level to changes in terrain, they deliver cutting-edge performance.

TimberMatic™ H-12 is a state-of-the-art machine-control system with an easy-to-use and -configure user interface that integrates base machine control with its measuring system. Configurable user interface comes standard.

Other innovative advantages including TimberLink™ monitoring system, hydraulically driven fan, and easy engine access help speed servicing, minimize maintenance, and lower daily operating costs. Whether you're handling small-diameter thinning or large timber regeneration harvesting, there's a hard-working E-Series Harvester with the power and agility to meet your needs.

John Deere PowerTech™ engines provide the right technology, right now. Easy to operate and maintain while delivering superior power, fuel efficiency, and reliability, our EPA Interim Tier 4 (IT4)/EU Stage IIIB technology is backed by a comprehensive worldwide network of Deere dealer service locations.

The compact four- or six-wheeled 1070E and six-wheeled 1170E Harvesters are agile and productive, especially for late-thinning and early final-felling operations. Superior tractive force-to-weight ratios combined with tight turning radiuses and high ground clearances make it easy to maneuver in difficult terrain.

With tireless power to handle large trees, the 1270E Harvester is the most-wanted all-around wheeled harvester in the world. The 1270E is also now available in an all-new eight-wheel-drive option for conditions that call for maximum traction and climbing ability.

For ultimate harvesting productivity, choose the stable, smooth 1470E Harvester. Equipped with a new CH9 rigid boom, the 1470E is the logger's choice for large timber and extreme conditions.



Automate logging. Accelerate productivity. Elevate uptime.

E-Series Harvesters continue the long Deere history of harnessing state-of-the-art technology to make your operator more productive — and your operation more profitable. Fully adjustable armrests including mounted keypads provide comfortable, fingertip control of all machine functions.

The TimberMatic H-12 automation system optimizes production, timber measurement, and base machine-control functions. And TimberLink constantly monitors performance and machine health so you can increase productivity and uptime, while minimizing fuel expenses and other daily operating costs.

Exclusive TimberLink system constantly monitors machine performance, providing information on fuel consumption, productivity, and time management for all stages of the harvesting process.

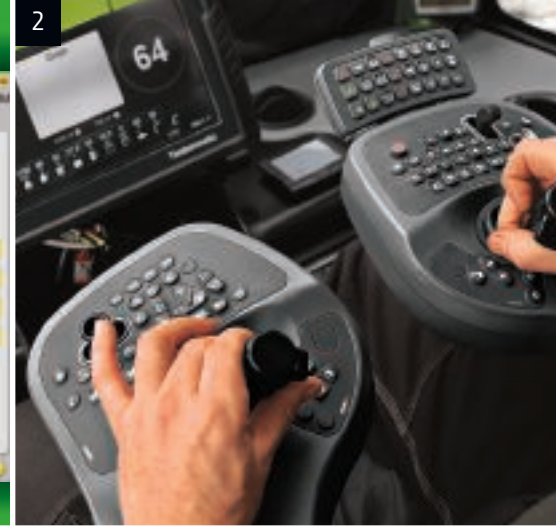
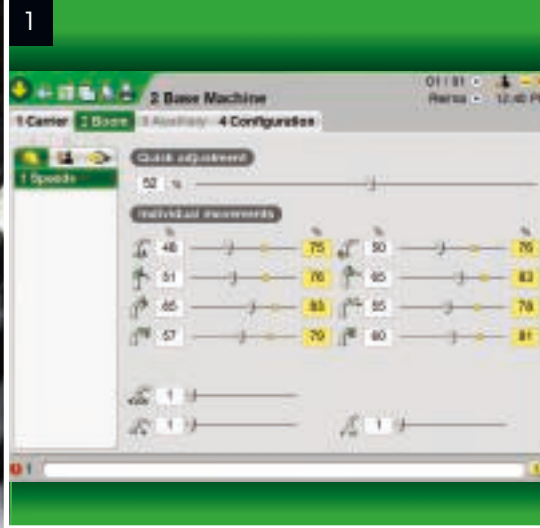

1. The TimberMatic H-12 system ensures high productivity and easy operation by allowing operators to fine-tune all machine and harvester-head settings to personal preferences. Shortcut keys make it easy to make measuring, bucking, and basic machine adjustments.
2. Comfortable armrests with mounted controls are fully adjustable, putting intuitive control of all machine functions at your fingertips.
3. Standard twin-power halogen lights extend the workday. Xenon lights are also available.



Processing Power Control (PPC) lowers operating costs and increases productivity by five to 15 percent by balancing processing power and fuel economy in a variety of logging applications. Just select the desired power level, and advanced timber software takes care of the rest. TimberLink displays the results on the PC monitor.

Three PPC power-level settings deliver unmatched power and efficiency:

- Level 1: Small-diameter trees
- Level 2: Medium tree sizes
- Level 3: Thick and heavy trunks

PPC comes standard on all E-Series Harvesters.

Ultimate Uptime, featuring John Deere ForestSight™, is a customizable support solution available exclusively from your Deere dealer. This flexible offering maximizes equipment availability with standard John Deere ForestSight capabilities that can help prevent future downtime and speed repairs when it does occur. In addition to the base John Deere ForestSight features, our dealers work with you to build an uptime package that meets the specific needs of your machine, fleet, project, and business, including customized maintenance and repair agreements, onsite parts availability, extended warranties, fluid sampling, response-time guarantees, and more.



Turns every head but your operator's.

The exceptional productivity of our E-Series Harvesters has been turning a lot of heads. But working in the fully adjustable air-cushioned seat, your operator will stay focused on the job at hand. Rotating and auto-leveling cab, large windows, and low-mounted console provide a clear sightline to the business end of the boom and the harvester head. Low noise and vibration levels minimize fatigue, while the climate-controlled interior keeps things comfortable year-round. And the roomy cab's many amenities provide all the fatigue-beating comfort your operator could want, including a food heater/cooler and plenty of storage space.

Revolutionary rotating cab tracks the boom up to 80 deg. in each direction so the operator can concentrate on the harvester head and the work at hand.

Sun blinds keep the cab cooler, prevent glare when working, and easily stow away when not in use.

Increased ground clearance and greater tractive force enable superior maneuverability.

Industry-exclusive bogie axles deliver excellent tractive effort in all terrain, lower ground pressure, and high ground clearance.



1. State-of-the-art optional auto-leveling cab quickly and smoothly adjusts to the slope of the terrain, reducing fatigue while boosting productivity.

2. Fully adjustable air-cushioned seat provides exceptional daylong comfort in the climate-controlled cab.

3. With a noticeably larger entryway, getting in and out of a John Deere E-Series Harvester has never been easier.

4. Large expanse of forward tinted glass and large side and rear windows allow virtually unrestricted all-around visibility.



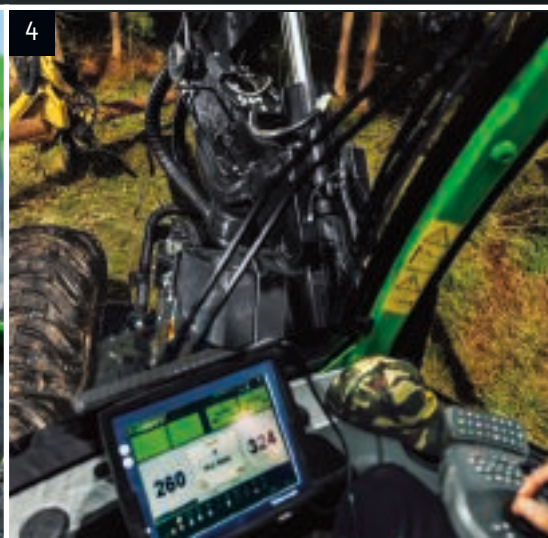



Experience a boom in productivity.

Superior new boom designs on our E-Series Harvesters deliver smoother, more accurate control. Impressive lifting and slewing torques allow booms to lift and swing larger loads with ease. Using the TimberMatic H-12 control system, with saw-sequence control and configurable user interface, operators can customize controls for exacting boom-movement command. John Deere harvester heads combine timber-cutting power with excellent delimiting quality to the smallest diameter range. Choose from multiple reach options on all parallel harvester booms and from a wide range of harvester heads to customize your machine to your application. And put more productivity within reach.



The 1470E boasts a durable new CH9 boom for improved lifting and slewing torque, and hydraulics to move even larger loads smoothly and accurately.

TimberMatic H-12 control system with its fine-tuned hydraulics provides more precise, quicker boom movements, for greater productivity.



1. CH6 parallel harvester boom on the 1170E combines easy handling with enormous slew-power ratings. Combine with the H414 harvester head for all-around utility from late thinning to regeneration harvesting.

2. Powerful, precise CH7 parallel harvester boom on the 1270E provides more lifting as well as slewing torque, for greater agility for late thinnings and felling operations.

3. Reliable 180S boom on the 1070E is known for its easy-to-handle geometry.

Paired with 1270E and 1470E Harvesters, the H480C harvester head is hard to beat. New twin-pump hydraulic system employs two loops: one for harvester head and transmission control, and one for head and boom control.

The 1070E's H412 harvester head is perfect for thinning and small timber. This compact, extremely durable head features superior power-to-weight ratio, slip-free four-wheel feeding, and excellent delimiting quality.

Equip your harvester head with the optional multi-tree-handling device and raise productivity to even higher levels — especially in early thinnings with energy wood collection.

H400-Series harvester heads allow delimiting customized to specific tree species and harvesting applications.

With greater power, higher tractive force, and more ground clearance than its six-wheeled counterpart, the new eight-wheel-drive 1270E Harvester option is designed to improve traction

and maneuverability. Wider approach angle helps stabilize the machine in demanding terrain such as on steep slopes and in soft soil conditions.

With its four-wheel-drive feed and six-knife design, the 1170E's H414 harvester head is excellent for thinning and final felling operations.

Redesigned H413 and H415 harvester heads feature solid-grip feed rollers to reliably handle a wide range of harvesting jobs and deliver superior delimiting quality.



Nothing runs like a Deere because nothing is built like one.

You work long and hard — and we designed our E-Series Harvesters to do the same. Reliability- and durability-boosting enhancements include rugged, reinforced boom cylinders and valve, automatic chain lubrication and tensioning, and hydraulically driven fan. Service is simple and quick, with checkpoints grouped beneath a tilting engine hood. Self-cleaning engine air filter, extended service intervals, and intuitive diagnostics further increase uptime. When you know how they're built, you'll run a Deere.

1. The electric-motor-powered engine hood is split into two sections and tilts up for fast, easy access to daily checkpoints. Hydraulically driven variable-speed fan runs only as needed, reducing fuel consumption and debris flow through the cooler cores. It's programmable to reverse at periodic intervals to clear core-clogging buildup.
2. For easier maintenance access to internal components, simply swing open the service door. Plenty of storage is built in under a lid on the steps, and access is easy via the rear trough steps.
3. Boom-tilt cylinders are located in front of the boom for greater efficiency and long life. Exclusive heavy-duty bogie axles ensure superior maneuverability in rough terrain.
4. If something goes wrong, the easy-to-navigate monitor displays fault codes and diagnostics to help speed troubleshooting. It also issues an audible warning if immediate shutdown is necessary or a less critical malfunction has occurred.

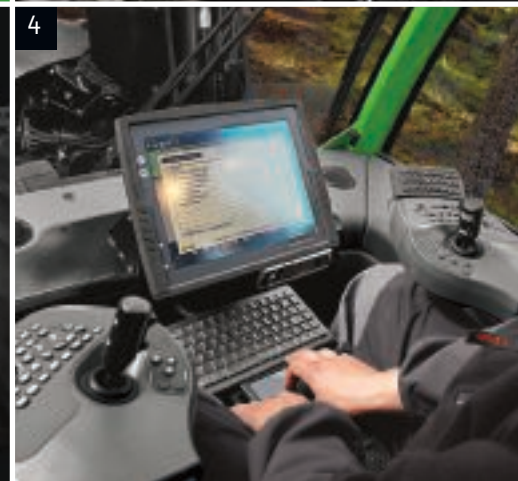
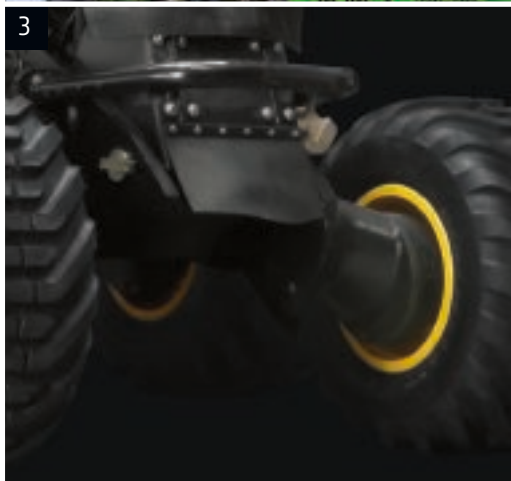

John Deere ForestSight is an exclusive suite of telematic solutions that increases uptime while lowering operating costs. At its heart, JDLink™ Ultimate machine monitoring provides real-time data and health prognostics to suggest maintenance solutions that decrease costly downtime. Remote diagnostics enable your dealer to read codes, record performance data, and even update software without a trip to the jobsite.

Our IT4/Stage IIIB technology is simple, fuel efficient, fully integrated, and fully supported. It employs field-proven cooled exhaust gas recirculation (EGR) for reducing NO_x and a diesel particulate filter (DPF) and diesel oxidation catalyst (DOC) to reduce particulate matter.

Self-cleaning engine air filter extends the lifetime of the filter.

PowerCore® engine air prefilter also helps prolong service intervals, lowering overall operating costs.

Long engine oil and filter service intervals decrease planned downtime and expense.

Optional off-line oil filter located inside the hydraulic oil tank improves filtration, for a cleaner hydraulic system and longer system life.

Reliable and flexibly interchangeable electronic controllers reduce machine downtime. Commonality among the basic components of all John Deere Forestry equipment lowers your investment in service parts.

1070E / 1170E / 1270E / 1470E

Engine	1070E	1170E	1270E	1470E
Manufacturer and Model	John Deere PowerTech™ Plus 6068		6-Wheel John Deere PowerTech Plus 6090	8-Wheel John Deere PowerTech Plus 6090
Non-Road Emission Standard	EPA Interim Tier 4 / EU Stage IIIB	EPA Interim Tier 4 / EU Stage IIIB	EPA Interim Tier 4 / EU Stage IIIB	
Engine Displacement	6.8 L (415 cu. in.)	6.8 L (415 cu. in.)	9.0 L (549 cu. in.)	9.0 L (549 cu. in.)
Net Peak Power at 1,900 rpm	136 kW (182 hp)	145 kW (194 hp)	170 kW (228 hp)	190 kW (255 hp)
Net Peak Torque	850 Nm (627 lb.-ft.) at 1,400 rpm	935 Nm (690 lb.-ft.) at 1,400 rpm	1125 Nm (830 lb.-ft.) at 1,200–1,400 rpm	1250 Nm (920 lb.-ft.) at 1,200–1,400 rpm
Fuel Tank Capacity	300 L (79.3 gal.)	300 L (79.3 gal.)	435 L (115 gal.)	390 L (103 gal.)
Transmission				
Hydrostatic-mechanical, 2-speed gearbox				
Tractive Force	130 kN (29,200 lb.)	150 kN (33,700 lb.)	175 kN (39,240 lb.)	210 kN (47,210 lb.)
Travel Speed				
Gear 1	0–7.5 km/h (0–4.7 mph)	0–7.5 km/h (0–4.7 mph)	0–7.5 km/h (0–4.7 mph)	0–7.0 km/h (0–4.3 mph)
Gear 2	0–24 km/h (0–15 mph)	0–24 km/h (0–15 mph)	0–22 km/h (0–13.7 mph)	0–21 km/h (0–13.0 mph)
Steering				
Proportional frame steering with mini levers				
Turning Angle	± 44 deg.	± 44 deg.	± 44 deg.	± 44 deg.
Brakes				
1070E / 1170E / 1270E / 1470E				
Service/Work	Hydraulically actuated, oil-immersed, multi-disc			
Parking/Emergency	Spring actuated			
Frame Oscillation	Automated			
Axles/Bogies				
1070E				
1170E				
1270E				
1470E				
Hydromechanical differential lock at front and rear				
Axles				
Front	Balanced bogie axles; rigid axle (1070E 4W)	Balanced bogie axles; rigid axle	Heavy-duty Duraxle™ balanced bogie axles	
Rear	Rigid axle	Rigid axle	Rigid axle	Heavy-duty Duraxle balanced bogie axles
Electrical				
Voltage	24 volt	24 volt	24 volt	24 volt
Batteries	2 x 145 Ah	2 x 145 Ah	2 x 145 Ah	2 x 145 Ah
Alternator	150 A (28 volt)	150 A (28 volt)	150 A (28 volt)	150 A (28 volt)
Lights	Halogen: 10 work, 4 boom, and 6 thinning	Halogen: 10 work, 4 boom, and 6 thinning	Halogen: 10 work, 4 boom, and 6 thinning	
Optional	LED	LED	LED	LED
Hydraulics				
Main Pump	Load sensing, power adjustable		Load sensing, power adjustable, double-pump system	
Pump Capacities	160 cm³ (9.7 cu. in.)	175 cm³ (10.7 cu. in.)	190 cm³ (11.6 cu. in.) / 180 cm³ (10.9 cu. in.)	
Operating Pressure	24 / 28 MPa (3,480 / 4,060 psi)	24 / 28 MPa (3,480 / 4,060 psi)	28 MPa (4,060 psi)	28 MPa (4,060 psi)
Hydraulic Tank	170 L (44.9 gal.)	170 L (44.9 gal.)	300 L (79.3 gal.)	300 L (79.3 gal.)
Boom				
Type	180S	CH6	CH7	CH9
Maximum Reach Lengths	8.6 m (28.2 ft.) / 10 m (32.8 ft.) / 10.8 m (35.5 ft.)	10 m (32.8 ft.) / 11.3 m (37.1 ft.)	8.6 m (28.2 ft.) / 10 m (32.8 ft.) / 11.7 m (38.4 ft.)	
Gross Lifting Torque	143 kNm (105,500 lb.-ft.)	165 kNm (121,700 lb.-ft.)	197 kNm (145,300 lb.-ft.)	197 kNm (145,300 lb.-ft.)
Slewing Torque	38 kNm (28,000 lb.-ft.)	45 kNm (33,200 lb.-ft.)	50 kNm (36,880 lb.-ft.)	50 kNm (36,880 lb.-ft.)
Slewing Angle	220 deg.	220 deg.	220 deg.	220 deg.
Tilt Angle, Forward / Back	+28 / -14 deg.	+28 / -14 deg.	+28 / -15 deg.	+28 / -15 deg.
Cabin				
Leveling and rotating, or fixed cabin				
Rotating Angle	160 deg.	160 deg.	160 deg.	160 deg.
Sideways Tilt	17 deg.	17 deg.	17 deg.	17 deg.
Forward and Backward Tilt	10 deg.	10 deg.	9 deg.	9 deg.



Measuring and Control System		1070E / 1170E / 1270E / 1470E			
Type	PC / Windows-based TimberMatic H-12				
Harvester Heads	1070E	1170E	1270E	1470E	
Model	H752HD, H754, H412, H413, and H414	H752HD, H754, H412, H413, and H414	H752HD, H754, H413, H414, H415, H270, and H480C	H270, H415, H480C, and H290	

Measurements*						
	4-Wheel	6-Wheel	6-Wheel	6-Wheel	8-Wheel	8-Wheel
A Length	6435 mm (253 in.)	6920 mm (272 in.)	7180 mm (283 in.)	7695 mm (303 in.)	7927 mm (312 in.)	7845 mm (309 in.)
B Front Axle – Middle Joint	1850 mm (73 in.)	1850 mm (73 in.)	1950 mm (77 in.)	2150 mm (85 in.)	2150 mm (85 in.)	2150 mm (85 in.)
C Rear Axle – Middle Joint	1850 mm (73 in.)	1850 mm (73 in.)	1850 mm (73 in.)	2050 mm (81 in.)	2280 mm (90 in.)	2050 mm (81 in.)
D Wheelbase	3700 mm (146 in.)	3700 mm (146 in.)	3800 mm (150 in.)	4200 mm (165 in.)	4430 mm (174 in.)	4200 mm (165 in.)
Tires, Front	34–14 / 26.5–12 (20)	22.5–16	24.5–20	26.5–20	26.5–20	26.5–20
Tires, Rear	34–14 / 26.5–12 (20)	34–14 / 26.5–12 (20)	34–14	34–14	26.5–20	34–16
E Width						
600-Series Tires	2600 mm (103 in.)	2660 mm (105 in.)	N/A	2750 mm (108 in.)	2750 mm (108 in.)	N/A
650-Series Tires	2710 mm (107 in.)	N/A	2720 mm (107 in.)	N/A	N/A	2990 mm (118 in.)
710-Series Tires	N/A	2820 mm (111 in.)	2820 mm (111 in.)	2960 mm (117 in.)	2960 mm (117 in.)	N/A
750-Series Tires	N/A	N/A	N/A	N/A	N/A	2990 mm (118 in.)
Outer Turning Radius						
650-Series Tires	5860 mm (231 in.)	N/A	N/A	N/A	N/A	N/A
710-Series Tires	N/A	6020 mm (237 in.)	6150 mm (242 in.)	6675 mm (263 in.)	7105 mm (280 in.)	N/A
750-Series Tires	N/A	N/A	N/A	N/A	N/A	6825 mm (269 in.)
Inner Turning Radius						
650-Series Tires	3080 mm (121 in.)	N/A	N/A	N/A	N/A	N/A
710-Series Tires	N/A	3250 mm (128 in.)	3330 mm (131 in.)	3805 mm (150 in.)	3990 mm (157 in.)	N/A
750-Series Tires	N/A	N/A	N/A	N/A	N/A	3680 mm (145 in.)
Transport Height	3640–3740 mm (143–147 in.)	3675 mm (145 in.)	3720 mm (146 in.)	3985 mm (157 in.)	3880 mm (153 in.)	3930 mm (155 in.)
F Ground Clearance – Middle Joint	560–640 mm (22–25 in.)	575 mm (23 in.)	625 mm (25 in.)	640 mm (25 in.)	715 mm (28 in.)	750 mm (30 in.)
Minimum Machine Weight [with harvester head model]	15 050 kg (33,180 lb.) [H412]	15 750 kg (34,723 lb.) [H412]	17 800 kg (39,242 lb.) [H754]	20 500 kg (45,200 lb.) [H480C]	22 800 kg (50,265 lb.) [H480C]	21 700 kg (47,840 lb.) [H480C]

*Note: Measurements are nominal and may vary depending on manufacturing tolerances.

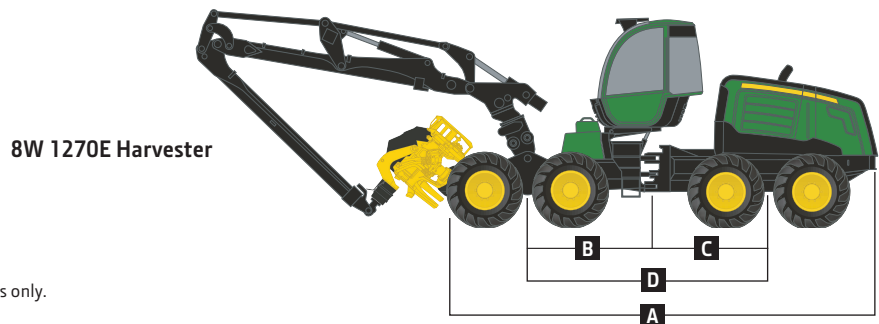
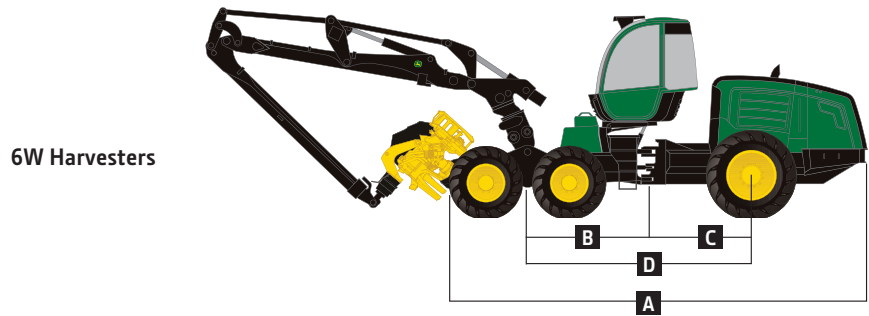
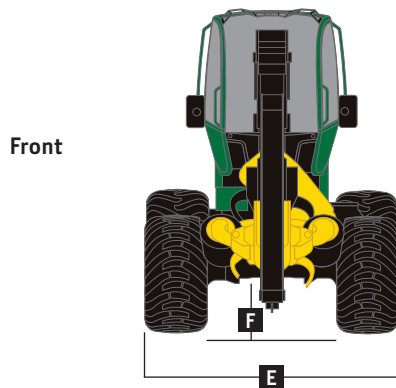

Machine not exactly as shown. Illustrations for dimensioning purposes only. Specifications are subject to change without notice.



Logging is a way of life. A calling passed down through the generations. One that gets into your blood and takes everything you've got. But one that you'll never give up. And that's why we're dedicated to providing equipment and solutions specifically for the work you do. **Combine our technology with your work ethic to get the job done.**

We're for Loggers



JOHN DEERE

JohnDeere.com/forestry